

PROJECT	NOTES	TYPE	DATE	CAT. No.
---------	-------	------	------	----------



LNS

CCT Adjustable LED Narrow Strip

The LNS series LED Narrow Strip delivers industry-leading performance with deep energy savings and continuous dimming. Low profile design offers easy handling and storage. This versatile luminaire produces energy-efficient, comfortable illumination for a myriad of applications. Excellent for general utility applications; parking garage, warehouse, offices, restrooms, storage units and stairwells.



INPUT VOLTAGE	120-277V
INPUT FREQUENCY	50/60 Hz
RATED WATTAGE	See Performance Data
DELIVERED LUMENS	See Performance Data
EFFICACY	120 LPW (typ.)
CRI	80
AVAILABLE CCT	3000K, 4000K, 5000K
LENS TYPE	Plastic

RATED LIFE	50,000hrs (Based on 3hrs a Day)
L70	>50,000hrs
POWER FACTOR	>0.9
THD	<20%
DIMMING	0-10V Continuous (10-100%)
OPERATING TEMP.	-4°F - 113°F / -20°C to 45°C
BEAM ANGLE	N/A

ORDER INFO / EXAMPLE: LNS-4-26-MVD-830/40/50

SERIES	LENGTH	RATED WATTAGE	DRIVER TYPE	COLOR TEMP
LNS	4	26	MVD	830/40/50
LNS CCT Adjustable LED Narrow Strip	2-24" 4-48" 8-96"	24" Housing 17- 17W, 2210 Lumens 48" Housing 26- 26W, 3380 Lumens 34- 34W, 4420 Lumens 45- 45W, 5850 Lumens 96" Housing 55- 55W, 7150 Lumens 90- 90W, 11700 Lumens	MVD- 120-277V, 0-10V Dimming HVD- 348-480V, 0-10V Dimming	830/40/50- 3000K, 4000K, 5000K CCT Adjustable; 80+CRI
			OPTIONS / ACCESSORIES	

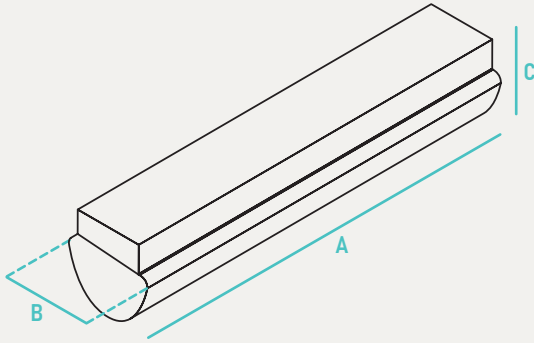

PERFORMANCE DATA

FORM FACTOR	KELVIN	RATED WATTAGE	DELIVERED LUMENS	EFFICACY (LM/W)
2'	3K/4K/5K	17W	2210	120
4'	3K/4K/5K	26W	3380	120
4'	3K/4K/5K	34W	4420	120
4'	3K/4K/5K	45W	5850	120
8'	3K/4K/5K	55W	7150	120
8'	3K/4K/5K	90W	11700	120

	A	B	C	Case QTY
LNS-2	24" L	3.3" W	3.6" H	6
LNS-4	48" L	3.3" W	3.6" H	1
LNS-8	96" L	3.3" W	3.6" H	1

QUICK SHIP

LNS-2-17-MVD-830/40/50 ¹	LNS-4-26-MVD-830/40/50 ¹
LNS-4-34-MVD-830/40/50 ¹	LNS-4-45-MVD-830/40/50 ¹
LNS-8-55-MVD-830/40/50 ¹	LNS-8-90-MVD-830/40/50 ¹

CONSTRUCTION

Injection molded trim with diffusion lens for optimal visual comfort while providing exceptional light output. Edge Lit technology and lens design and materials provide uniform appearance without pixelation.

ELECTRICAL

Equipped standard with 120-277V, 0-10V dimming driver.

QUALIFICATIONS

All luminaires are built to UL 1598 and 2108 standards, and bear appropriate ETL labels. Damp location labeling is standard. Emergency equipped fixtures labeled UL924. Adheres to LM70, LM80 and TM21 industry standards. Dedicated 120V Models are FCC Title 47 CFR, Part 15, Class B for residential and commercial applications.

INSTALLATION

Designed for mounting on 3" or 4" electrical J-Box.

WARRANTY

5-year Limited Warranty. See warranty documentation for more info.

ADDITIONAL IMAGES

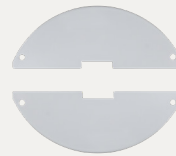
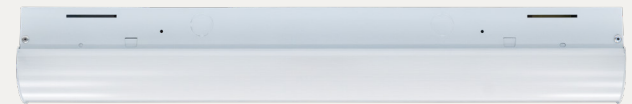
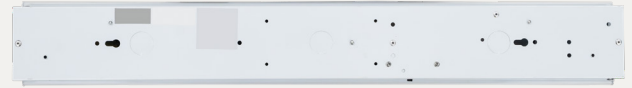

BACK BRACKET INCLUDED

RECOMMENDED DIMMERS

WBSD-010DEC (Cooper)	WBSD-010SLD (Cooper)
DF10P (Cooper)	

PHOTOMETRIC DATA

LNS-2-17

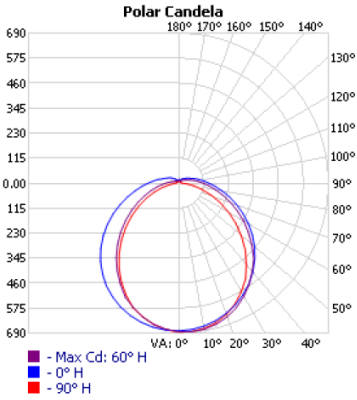

Zonal Lumen Summary

Zone	Lumens	% Lamp	% Luminaire
0-30	529.1	22.3%	22.3%
0-40	866.8	36.6%	36.6%
0-60	1,543.9	65.2%	65.2%
60-90	593.9	25.1%	25.1%
70-100	411.7	17.4%	17.4%
90-120	171.8	7.3%	7.3%
0-90	2,137.8	90.3%	90.3%
90-180	230.5	9.7%	9.7%
0-180	2,368.3	100%	100%

LNS-4-26

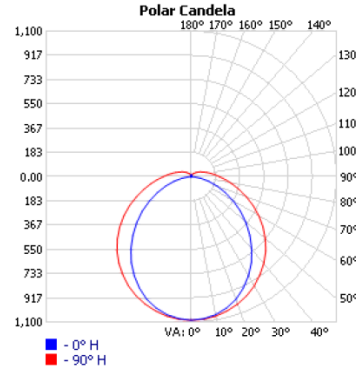

Zonal Lumen Summary

Zone	Lumens	% Lamp	% Luminaire
0-30	840.1	22.9%	22.9%
0-40	1,373.7	37.5%	37.5%
0-60	2,438.7	66.5%	66.5%
60-90	908.9	24.8%	24.8%
70-100	614.9	16.8%	16.8%
90-120	245.5	6.7%	6.7%
0-90	3,347.6	91.3%	91.3%
90-180	317.0	8.6%	8.7%
0-180	3,664.6	99.9%	100%

LNS-4-34

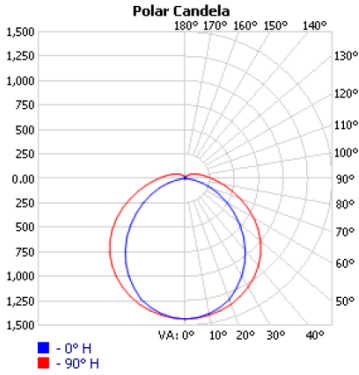

Zonal Lumen Summary

Zone	Lumens	% Lamp	% Luminaire
0-30	1,118.8	22.7%	22.7%
0-40	1,837.4	37.3%	37.3%
0-60	3,287.9	66.7%	66.8%
60-90	1,224.3	24.8%	24.9%
70-100	815.5	16.6%	16.6%
90-120	317.7	6.4%	6.5%
0-90	4,512.1	91.6%	91.6%
90-180	411.2	8.3%	8.4%
0-180	4,923.3	99.9%	100%

LNS-4-45

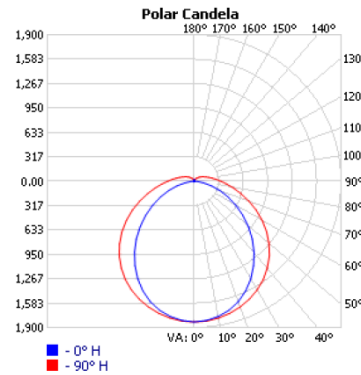

Zonal Lumen Summary

Zone	Lumens	% Lamp	% Luminaire
0-30	1,418.7	22.8%	22.8%
0-40	2,327.9	37.4%	37.5%
0-60	4,155.8	66.9%	66.9%
60-90	1,544.9	24.9%	24.9%
70-100	1,030.0	16.6%	16.6%
90-120	398.0	6.4%	6.4%
0-90	5,700.7	91.7%	91.8%
90-180	510.4	8.2%	8.2%
0-180	6,211.1	99.9%	100%

Made to order items. Minimum 90 day lead time. Minimum order quantity may vary please contact sales.

¹ DLC Listed / ² DLC Premium Listed / ³ Title 24 / ⁴ JA8 & Title 24 / Typical color consistency. May vary or be changed.

L70 hours calculated based on LED package manufacturer LM80 report and ISTMT report of LED in luminaire. Stated values are for select catalog numbers. Contact Globalux for detailed information. / Actual performance may differ as a result of end-user environment and application. All values are design or typical values, measured under laboratory conditions at 25 °C.